

SB90

Produzione kg/24h
Production kg/24h - Production kg/24h
Tagesleistung kg /24/h - Produccion kg/24/h

100 A
100 W
100 AW

Capacità deposito kg.
Storage capacity kg - Capacité de dépôt kg
Vorratbehälter kg - Almacen kg

23

Potenza installata W
Installed power W - Puissance installée W
Verfügbare Leistung W - Potencia instalada W

620

Tensione standard
Standard voltage - Tension standard
Standardspannung - Standard voltajes

230-50-1

Dimensioni lorde mm
Gross dimensions mm - Dimensions brutes mm
Bruttoabmessungen mm - Dimensiones brutas mm

kg 65
Vol. m³ 0,33

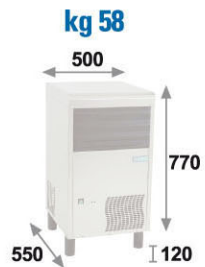
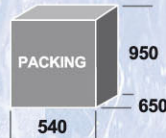

SB90 MAX

Produzione kg/24h
Production kg/24h - Production kg/24h
Tagesleistung kg /24/h - Produccion kg/24/h

100 A
100 W
100 AW

Capacità deposito kg.
Storage capacity kg - Capacité de dépôt kg
Vorratbehälter kg - Almacen kg

30

Potenza installata W
Installed power W - Puissance installée W
Verfügbare Leistung W - Potencia instalada W

620

Tensione standard
Standard voltage - Tension standard
Standardspannung - Standard voltajes

230-50-1

Dimensioni lorde mm
Gross dimensions mm - Dimensions brutes mm
Bruttoabmessungen mm - Dimensiones brutas mm

kg 65
Vol. m³ 0,36

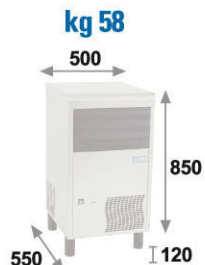
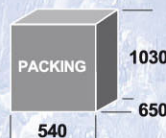

SB135

Produzione kg/24h
Production kg/24h - Production kg/24h
Tagesleistung kg /24/h - Produccion kg/24/h

130 A
135 W
135 AW

Capacità deposito kg.
Storage capacity kg - Capacité de dépôt kg
Vorratbehälter kg - Almacen kg

50

Potenza installata W
Installed power W - Puissance installée W
Verfügbare Leistung W - Potencia instalada W

800

Tensione standard
Standard voltage - Tension standard
Standardspannung - Standard voltajes

230-50-1

Dimensioni lorde mm
Gross dimensions mm - Dimensions brutes mm
Bruttoabmessungen mm - Dimensiones brutas mm

kg 91
Vol. m³ 0,6

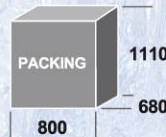

SB155

Produzione kg/24h
Production kg/24h - Production kg/24h
Tagesleistung kg /24/h - Produccion kg/24/h

150 A
160 W
160 AW

Capacità deposito kg.
Storage capacity kg - Capacité de dépôt kg
Vorratbehälter kg - Almacen kg

115

Potenza installata W
Installed power W - Puissance installée W
Verfügbare Leistung W - Potencia instalada W

960

Tensione standard
Standard voltage - Tension standard
Standardspannung - Standard voltajes

230-50-1

Dimensioni lorde mm
Gross dimensions mm - Dimensions brutes mm
Bruttoabmessungen mm - Dimensiones brutas mm

kg 123
Vol. m³ 1,01

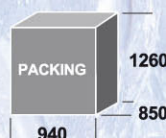

SB230

Produzione kg/24h
Production kg/24h - Production kg/24h
Tagesleistung kg /24/h - Produccion kg/24/h

220 A
230 W
230 AW

Capacità deposito kg.
Storage capacity kg - Capacité de dépôt kg
Vorratbehälter kg - Almacen kg

115

Potenza installata W
Installed power W - Puissance installée W
Verfügbare Leistung W - Potencia instalada W

1200

Tensione standard
Standard voltage - Tension standard
Standardspannung - Standard voltajes

230-50-1

Dimensioni lorde mm
Gross dimensions mm - Dimensions brutes mm
Bruttoabmessungen mm - Dimensiones brutas mm

kg 123
Vol. m³ 1,01

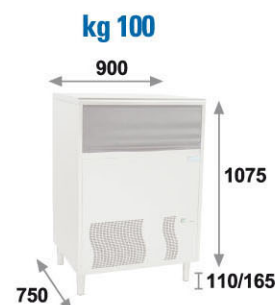
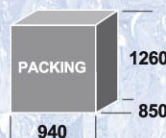

DETTAGLI / DETAILS



SB

	Altezza High	Larghezza Depth	Profondità Widht	Piede Leg	1 Cavo elettrico Electrical cord		2 Carico acqua Inlet water			3 Scarico acqua Water drain		
	mm	mm	mm	mm	mm	mm	mm	mm	Ø	mm	mm	mm
	A	B	C	D	L	H	L	H	Ø	L	H	Ø
SB90	770	500	550	120	105	130	40	150	3/4"	75	195	20
SB90 MAX	850	500	550	120	105	130	40	150	3/4"	75	195	20
SB135	935	760	600	110/165	140	285	40	305	3/4"	90	305	20
SB155	1075	900	750	110/165	140	285	40	305	3/4"	90	305	20
SB230	1075	900	750	110/165	140	285	40	305	3/4"	90	305	20

COLLEGAMENTI / CONNECTIONS

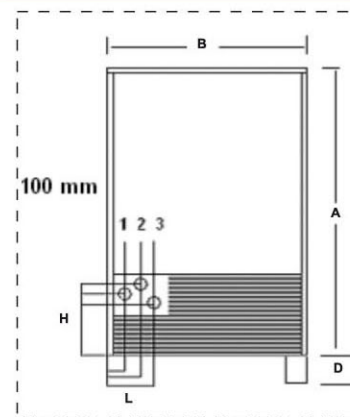

Prod. /24h

Temp	100% AW	100% W	100% A	100% AW
10°C	106%	100%	97%	83%
21°C	98%	97%	95%	80%
32°C	87%	84%	77%	66%
38°C	74%	71%	66%	58%

10°C 15°C 21°C 32°C

FLUSSO ARIA / AIR FLOW

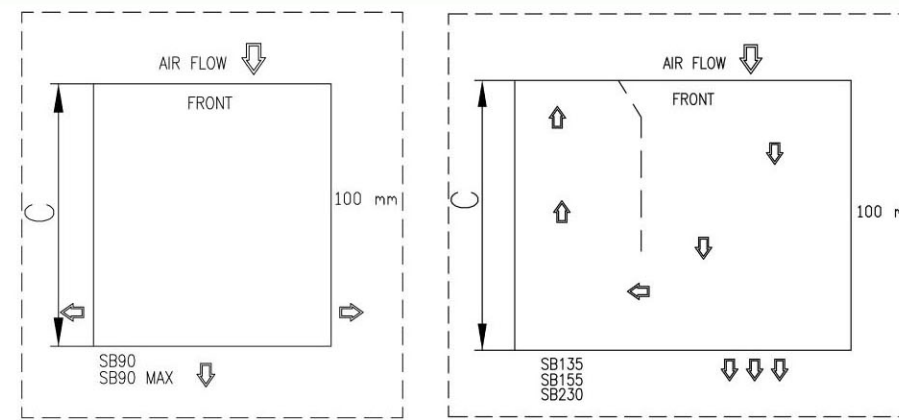

NOTE

- A = Condensazione ad aria / Air cooling / Refroidissement à air / Luftkühlung / Refrigeracion por aire
- W = Condensazione ad acqua / Water cooling / Refroidissement à eau / Wasserkühlung / Refrigeracion por agua
- AW = Condensazione mista / Mixed cooling / Refroidissement mixte / Gemischtegekühlung / Refrigeracion mixta
- S = Senza unità di condensazione / Condensation unit excluded / Exclue unité de condensation / Die Kondensationseinheit ist ausgeschlossen / Excluidos equipos condensacion
- AR = Condensatore ad aria remoto / Remote air cooled condenser / Condenseur à air deporté / Luftkondensator abgelegen / Condensador de aire a distancia

Tensione speciale a richiesta / Special tension on request / Tension particulière sur demande / Andere Anschlußspannungen auf Anfrage / Otra tensión bajo pedido

- L'indice massimo di produzione è riferito ad una temperatura ambiente di 15°C e temperatura acqua a 10°C
- Maximum production is based on a 15°C. ambient temperature and 10°C. water temperature
- L'index maximum de production est référé à une température ambiante de 15°C. et température de l'eau à 10°C
- Tagesleistung bei Raumtemperatur 15°C. und Wassertemperatur 10°C
- Produccion para temperatura ambiente de 15°C. e temperatura de agua 10°C